

SWEP M10, 016404.0-Preconfig

Configuration number (CN) with sort key: 016404.0-Preconfig

Denomination: M10NHx30/1P-CSN-S 4x1"

Number of plates (NoP): 30

Standard dimensions

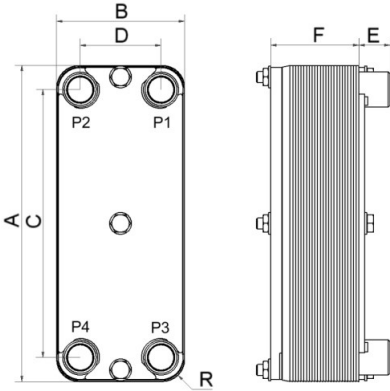

#	MM	IN
A	287	11.3
B	116	4.57
C	243	9.57
D	72	2.83
F	88	3.48
G	0	0
R	22	0.87

Measurement (Tolerance)

Preliminary Tolerances

Connections

F = Front side connections, P = Back side connections

POSITION	ART. NO.	DENOMINATION	HEIGHT (E)	MATERIAL
F1, F2, F3, F4	30178	ISO-G 1"	33	Stainless Steel 316

Accessories

Not visible in sketch

ART. NO.	DENOMINATION
----------	--------------

PED Pressure / Temperature

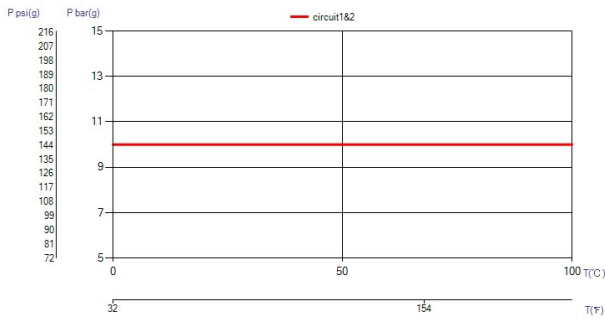

Product Data

PED Category	SEP
Total weight, including connections	8.0 kg
Total Heat Transfer area	0.7 m ² (7.2 ft ²)
Hold up volume circuit 1	0.588 dm ³ (0.021 ft ³)
Hold up volume circuit 2	0.63 dm ³ (0.022 ft ³)

MATERIALS

Carbon Steel Frame, 316 Stainless Steel Plates, NBR

Disclaimer

The information and recommendations in regards to the products are presented in good faith, however, SWEP makes no representations or warranties as to the completeness or accuracy of the information. Information is supplied upon the condition that the purchasers will make their own determination as to the products' suitability for their purposes prior to use. Purchasers should note that the properties of the products are both application and material selection dependent and that products containing stainless steel are still object to corrosion if used in unsuitable environments. Standard data is presented, product variants with different data may exist. Contact your SWEP sales representative for more details. SWEP may change any data without notice.